

STRUCTURAL AND REGIONAL DIFFERENCES OF NATURAL POPULATION GROWTH IN GERMAN CITIES, 1880–1905^{*)}

With 7 figures, 3 tables, and 1 supplement (I)

HANS-DIETER LAUX

Zusammenfassung: Strukturelle und regionale Unterschiede des natürlichen Bevölkerungswachstums deutscher Städte 1880–1905

Der folgende Beitrag ist Teil eines Forschungsprojektes zur Frage der Bevölkerungsentwicklung deutscher Städte zwischen 1871 und 1914. Diese Epoche der deutschen Wirtschafts- und Sozialgeschichte wird durch die – in vielfältigen Wechselbeziehungen zueinander stehenden – Prozesse der Industrialisierung, der Verstädterung und des stürmischen natürlichen Bevölkerungswachstums entscheidend geprägt. Dabei bleibt es eine bis heute nicht ausreichend geklärte Frage, in welchem Umfang das Wachstum der Städte durch die Zuwanderung oder die eigenständige natürliche Bevölkerungsentwicklung getragen wird. Die folgenden Ausführungen versuchen, einen Beitrag zu diesem Problemkreis zu liefern. Sie konzentrieren sich dabei auf eine Analyse der bemerkenswerten zwischenstädtischen Unterschiede des natürlichen Bevölkerungswachstums; Unterschiede, die bisher aufgrund des vorherrschenden Paradigmas des Stadt-Land-Gegensatzes zu wenig Beachtung fanden. Aufgrund der Quellenlage beschränkt sich die Untersuchung auf 64 der insgesamt 69 Städte Preußens mit mehr als 20 000 Einwohnern im Jahre 1880. Dabei wird in einem komparativ-statistischen Ansatz ein Vergleich der demographischen Strukturen in den Jahren 1880 und 1905 vorgenommen.

In einem ersten Untersuchungsschritt wird die Rate des natürlichen Bevölkerungswachstums in ihre grundlegenden demographischen Komponenten zerlegt. Eine statistische Analyse zeigt, daß die Unterschiede der natürlichen Bevölkerungsentwicklung sowohl 1880 als auch 1905 stärker durch das Niveau der Fruchtbarkeit als durch das Ausmaß der Sterblichkeit beeinflusst werden. Das Fertilitätsniveau – gemessen durch den „Index der Gesamfruchtbarkeit“ nach A. COALE – wird im Jahre 1880 in erster Linie durch die Unterschiede der Verheiratenquote bestimmt, während im Jahre 1905 die wechselnde Höhe der ehelichen Fruchtbarkeit von entscheidender Bedeutung ist.

Der zweite Teil der Untersuchung widmet sich der Erklärung der zwischenstädtischen Unterschiede von Verheiratenquote und ehelicher Fruchtbarkeit als den entscheidenden Komponenten des generativen Verhaltens. Die Analyse geht von der Annahme aus, daß das generative Verhalten der städtischen Bevölkerungen durch zwei weitgehend voneinander unabhängige Gruppen von Faktoren maßgebend beeinflusst wird. Auf der einen Seite sind dies Determinanten, die eng mit der kulturräumlichen – insbesondere der konfessionellen – Differenzierung des Landes zusammenhängen und zu mehr oder weniger klaren regionalen Verhaltensmustern führen, und auf der anderen Seite Einflußfaktoren, die primär mit der vorherrschenden ökonomischen Funktion der Städte und der sozio-ökonomischen Struktur ihrer Bewohner verbunden sind. Dabei ist zu erwarten, daß das Niveau der ehelichen Fruchtbarkeit in erster Linie durch die regionale Zugehörigkeit, das der Verheiraten-

quote hingegen durch die sozio-ökonomischen Faktoren bestimmt wird.

Die diskutierten Annahmen werden abschließend mit Hilfe des Verfahrens der „multiplen Klassifikationsanalyse“ einem eingehenden statistischen Test unterzogen. Zu diesem Zweck werden die Städte auf der Basis der beruflichen Tätigkeiten ihrer Bevölkerungen zu sieben funktionalen Typen zusammengefaßt bzw. entsprechend ihrer Lage vier möglichst homogenen kulturräumlichen Regionen zugeordnet. Die Ergebnisse der statistischen Analyse führen schließlich zu einer weitgehenden Bestätigung der aufgestellten Hypothesen.

In Germany the period between 1871 and 1914, i. e. from the foundation of the German Empire until the beginning of World War I, is characterized by the coincidence of a strong economic growth, which was caused by the industrial revolution, an explosive urbanization, and a maximal natural increase of population. It is noteworthy that this development differs considerably from the experience of Great Britain, which was industrialized much earlier, and France, which only shows a moderate increase in population. As EVERSLEY pointed out in his fundamental essay: "Population, Economy and Society" (1965), the above mentioned processes of industrialization, urbanization, and population growth are correlated with each other in manifold ways, the details of which have not yet been clarified.

The aim of the following paper is to discuss some aspects of this set of problems by concentrating on the analysis of the striking inter-city differences of the natural population growth in Germany. Undoubtedly, the persistent predominance of the rural-urban dichotomy can be held responsible for the remarkable lack of detailed investigation in these inter-city variations of demographic structures and processes (FRIEDLANDER 1973).

Data

The analysis is regionally restricted to the Prussian cities. This restriction is due to the unique quality and reliability of data collected and published by the Prussian Statistical Bureau¹⁾. The study is based on a sample of 64 cities. These are all the legal cities with more than 20,000 inhabitants in

^{*)} Erweiterte Fassung eines Referates, gehalten auf der "Conference on Historical Demography" des "Institute of British Geographers", Cambridge, 9.–11. September 1982.

¹⁾ For a fuller discussion of the statistical sources, see KNODEL (1974, 19–43).

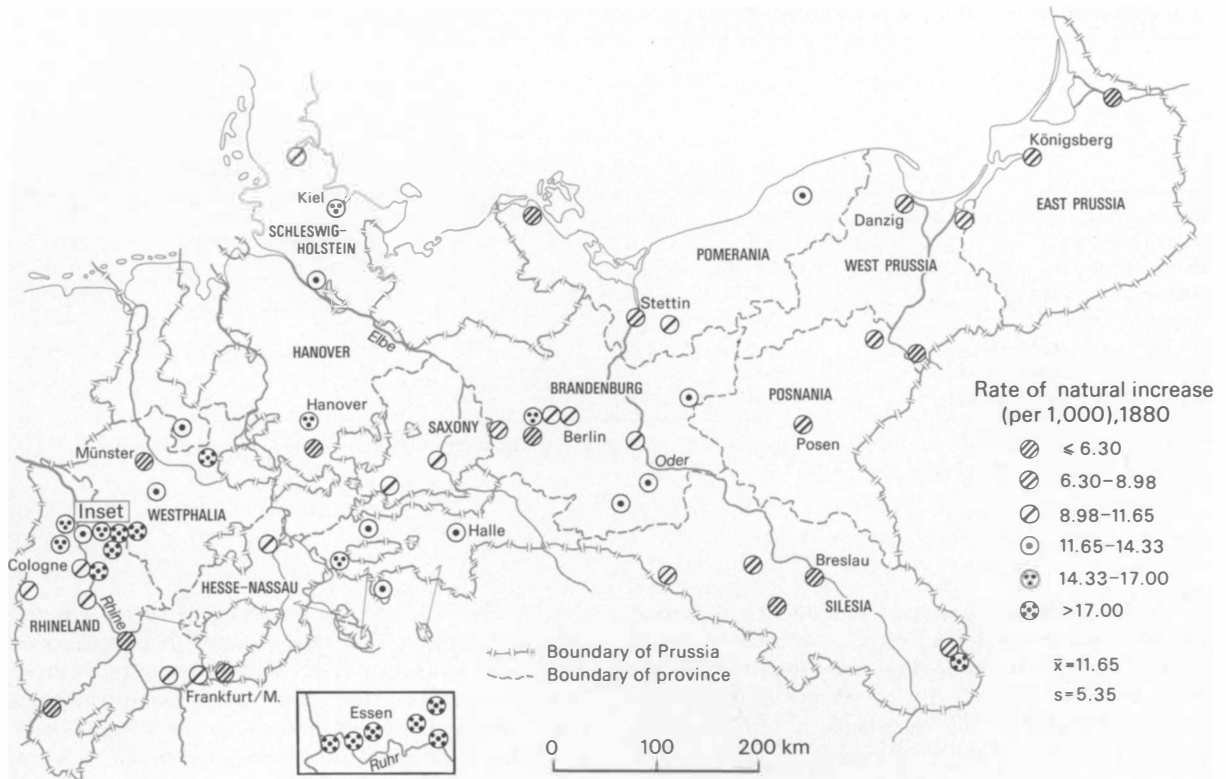

Fig. 1: Rate of natural population increase, 1880

1880 with the exception of 5 cases which had to be excluded due to incomplete data. The analysis is designed as a cross-sectional comparison of the demographic structures in 1880 with those in 1905. These years have been chosen because of the close proximity of the quinquennial population censuses to the aperiodic occupation and industrial censuses of 1882 and 1907. In addition to these census data the results of the annual vital registration were used for the calculation of a series of demographic indices. All these demographic measures refer to the average annual births and deaths during three-year periods centered on the census years.

Inter-city variation of natural population increase

A preliminary insight into the strong differentials of natural population growth among the Prussian cities is given by fig. 1. As can be seen from the map the rate of natural growth shows a distinct regional pattern in 1880. The highest growth rates of more than 1.4% can be found in the western parts of Prussia, namely in the provinces of Rhineland and Westphalia. This in particular holds true for the cities of the Ruhr area, represented on the small separate

map. In contrast, the provinces east of the river Elbe are characterized by figures mostly below average. Nevertheless, a detailed inspection shows that this overall regional pattern is disturbed to a greater or lesser degree in certain areas. Here the close neighbourhood of cities with rather different growth rates seems to be a characteristic feature. A preliminary analysis suggests that these variations are obviously associated with the different socio-economic structures of the cities. Thus it can be supposed that the inter-city variations of the intensity of natural growth are mainly determined by two more or less independent factors, i. e. regional location on the one hand and socio-economic structure of the cities on the other. It is the aim of the following paper to elaborate and to test this basic hypothesis in detail.

The components of natural population increase

In the first step of the study a comparative analysis of the demographic components of natural population increase will be carried out for 1880 and 1905. For this purpose a set of measures of fertility and mortality was calculated. These

Table 1: Demographic measures, 1880 and 1905 (N = 64)

	1880			1905		
	Mean	Standard deviation	Coefficient of variation	Mean	Standard deviation	Coefficient of variation
	(\bar{x})	(s)	(V)	(\bar{x})	(s)	(V)
Rate of natural increase (per 1,000) (r)	11.65	5.35	45.92	12.01	5.67	47.21
Overall fertility (I_f)	0.3654	0.0743	20.33	0.2931	0.0721	24.60
Marital fertility (I_g)	0.6990	0.0866	12.39	0.5368	0.1124	20.94
Illegitimate fertility (I_h)	0.0571	0.0248	43.43	0.0500	0.0215	43.00
Proportion married (I_m)	0.4764	0.0751	15.76	0.4970	0.0670	13.48
Life expectancy at birth (e_0)	36.04	3.47	9.63	44.96	3.73	8.30
Life expectancy at age one (e_1)	45.22	2.83	6.26	54.45	2.92	5.36
Infant mortality (per 1,000) (q_0)	222.26	51.26	23.06	192.71	37.91	19.67

Note: In 1905 the figures of e_0 and e_1 refer to a sample of 47 cities only. For this sample the values for 1880 are as follows: $e_0 = 35.94$ (\bar{x}), 3.41 (s), 9.48 (V); $e_1 = 45.11$ (\bar{x}), 2.71 (s), 6.01 (V).

are the four demographic indices developed by A. COALE, i. e. the "index of overall fertility (I_f)", the "index of marital fertility" (I_g), the "index of illegitimate fertility" (I_h), and the "proportion married" (I_m) on the one hand²⁾, and the mortality measures of "life expectancy at birth" (e_0), "life expectancy at age one" (e_1)³⁾, and "infant mortality" (q_0) on the other hand. Some basic statistics of these demographic measures and of the natural growth rate are given in table 1. Without discussing the table in detail the following findings should be noted: Marital fertility and life expectancy at birth are the two demographic dimensions which show the most intensive change of their overall level between 1880 and 1905. Obviously at this stage of demographic transition the general decline of mortality leads to a reduction of the intercity variations of life expectancy and infant mortality, whereas the birth decline is connected with an increasing variability of the fertility level (KULS 1979). It is remarkable that the interplay of these different demographic trends results in a considerable stability of the rate of natural increase between 1880 and 1905.

It seems to be appropriate now to look at the relations between the different demographic dimensions more

closely. This will be done by means of correlation and regression analysis. Thus table 2 shows the simple correlation coefficients between the selected demographic measures. The upper half of the matrix reports the coefficients for 1880, whereas the lower half shows the corresponding figures for 1905. In addition, the diagonal of the matrix presents the correlation coefficients of the indices in 1880 with these in 1905, thus indicating the similarity and persistence of demographic patterns and processes between the two dates.

It is not necessary to analyse the correlation matrix in detail because it serves as additional information only and as a preliminary step for the more complex approach reported in fig. 2. Here for the "rate of natural increase", a path model was constructed by multiple regression analysis.

The variables "overall fertility" and "life expectancy at birth" together explain 82.4% of the total variance of "natural increase" in 1880 and 85.7% in 1905, respectively. It can be seen from the path coefficients that the intensity of natural population growth is primarily determined by the variation of fertility, both in 1880 and in 1905. Moreover, it is remarkable that the two basic dimensions of natural growth are only weakly correlated. In contrast to the "rate of natural increase", these two demographic indices can be split up completely, i. e. by definition, into different components, namely "marital fertility", "illegitimate fertility", and "proportion married" on the one hand, and "infant mortality" and "life expectancy at age one" on the other. For the year 1880 the level of "infant mortality" seems to be the more important component for the variation of "life expectancy at birth", whereas in 1905 "life expectancy at age one" shows a slight preponderance. In spite of a correlation coefficient of $r = -0.459$ between "infant mortality" and "life expectancy at age one" in 1905, these two variables can be considered as largely independent dimensions of mortality, thus showing different regional patterns connected with distinct sets of death causes. It must be noted, however, that

²⁾ For a detailed discussion of the demographic indices, see COALE (1969, 4–6). The "index of overall fertility" (I_f) measures the extent to which women in a given population approach the number of births to be expected if all were subject to the highest schedule of age-specific fertility on reliable record, i. e. the fertility of married Hutterite women in 1921–1930. The "index of marital fertility" (I_g) indicates how closely the fertility of married women approaches the Hutterite level. The "index of illegitimate fertility" (I_h) indicates how closely the fertility of unmarried women approaches the level of married Hutterites. The index of "proportion married" (I_m) can be interpreted as the proportion of married women in the child-bearing ages, i. e. from 15 through 49.

³⁾ For 1905 the two measures of life expectancy could be calculated only for a sample of 47 cities.

Table 2: Correlation matrix: Demographic measures, 1880 and 1905 (N=64)

	r	I _f	I _g	I _h	I _m	e ₀	e ₁	q ₀
Rate of natural increase (per 1,000) (r)	0.734	0.806	0.547	-0.239	0.762	0.392	0.006	-0.593
Overall fertility (I _f)	0.817	0.758	0.736	-0.190	0.886	-0.031	-0.384	-0.341
Marital fertility (I _g)	0.665	0.847	0.757	-0.491	0.372	-0.085	-0.504	-0.364
Illegitimate fertility (I _h)	-0.222	-0.044	-0.225	0.863	-0.099	-0.324	0.098	0.578
Proportion married (I _m)	0.601	0.632	0.160	0.014	0.870	0.108	-0.141	-0.320
Life expectancy at birth (e ₀)	0.169*	-0.301*	-0.327*	-0.509*	0.036*	0.654*	0.745	-0.774
Life expectancy at age one (e ₁)	-0.124*	-0.506*	-0.569*	-0.317*	0.001*	0.877*	0.693*	-0.157
Infant mortality (per 1,000) (q ₀)	-0.481	-0.072	-0.064	0.573	-0.148	-0.829*	-0.459*	0.780

* N=47

Note: 0.806: Coefficients for 1880, 0.817: Coefficients for 1905, 0.734: Coefficients of the indices 1880 with those in 1905.

the results for 1880 and 1905 can only be compared with reservation because the variables concerning life expectancy could be calculated only for a sample of 47 cities in 1905.

In contrast to other parts of Germany, such as Saxony or Bavaria for example, the Prussian cities are generally characterized by comparatively low levels of illegitimacy. Thus the extent of “overall fertility” can be largely expressed as the product of “marital fertility” and the “proportion married”. As can be seen from the path coefficients, the level of “overall fertility” in 1880 is primarily determined by the “proportion married”, whereas in 1905 “marital fertility” seems to be the crucial variable. This shift must be interpreted as the result of the increasing variability of the index of marital fertility, already reported in table 1. This increased variation can be attributed to remarkable inter-city differences in the intensity of fertility decline.

It is noteworthy that “marital fertility” and “proportion married” are weakly but nevertheless positively correlated in 1880 as well as in 1905. This result is contradictory to the findings of J. KNODEL, reported in his study of the fertility decline in Germany between 1871 and 1939, where for the whole German Empire a correlation coefficient of $r = -0.451$ can be found for 1880 and of $r = -0.454$ for 1910, respectively (KNODEL 1974, 74). The coefficients were calculated on the basis of 71 administrative areas. These results lend support to the widely discussed and accepted hypothesis of a self-regulating demographic system, which is characterized by an inverse relationship of marital fertility and marriage frequency. But obviously this homeostasis hypothesis does not hold true on a lower level of aggregation, i.e. on the basis of individual cities for instance. This problem will be discussed in greater detail later in the paper.

Inter-city variations of reproductive behaviour

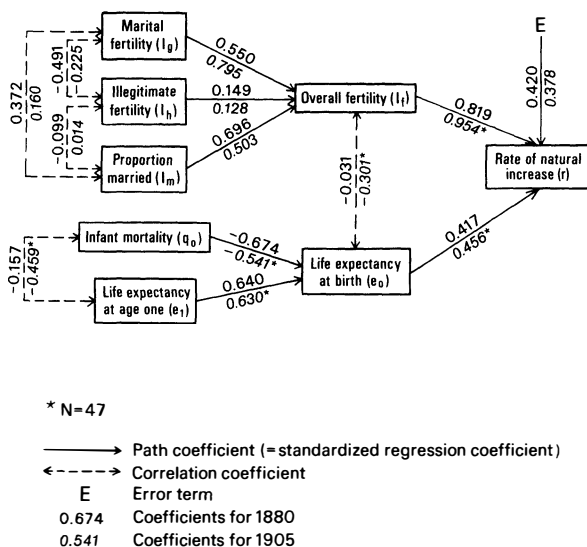

Fig. 2: Path model: Rate of natural increase, 1880 and 1905

At this point of the study it is necessary to give more precise information about the inter-city variations of the demographic processes in Prussia. Above all, this will be done by means of a sequence of maps presenting the four fertility indices developed by A. COALE. The presentation and the following analysis is restricted to these demographic measures because fertility has proved to be the crucial component of natural increase. As table 2 demonstrates, the patterns of the fertility measures of 1880 and 1905 are highly correlated. Therefore it seems to be justified to confine the presentation to the demographic indices in 1880. As can be seen from fig. 3 the index of “marital fertility” shows a distinct regional pattern in 1880. The highest values can be found in the provinces of Rhineland and Westphalia, whereas the cities of Brandenburg, Saxony, Hanover, and Hesse-Nassau, in particular, are characterized by figures mostly below average. It is an interesting question, whether the map still reflects different pre-decline levels of marital fertility or whether the striking regional differences are already the result of a birth decline, regionally more or less intensive. It is emphasized by J. KNODEL (1974), that there is

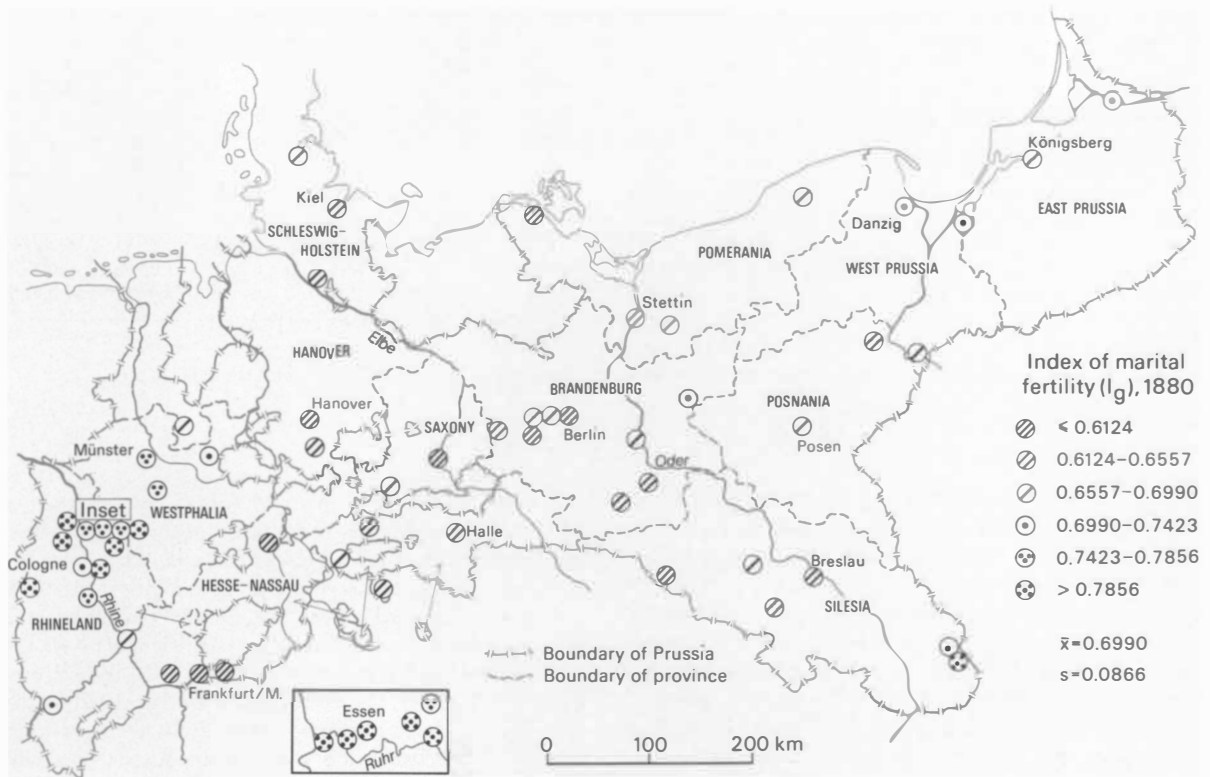

Fig. 3: Index of marital fertility (I_g), 1880

a great regional diversity in the pre-decline levels of marital fertility within Germany. Two different explanations for this diversity are discussed by KNODEL, without giving a clear preference. On the one hand, it can be supposed that the regional differences represent diverse levels of natural fertility. But it can also be assumed that at least some sectors of the populations practiced birth control before the onset of the fertility decline (KNODEL 1974, 58–61). Nevertheless, it can be supposed that the map presented reflects the levels of marital fertility in the Prussian cities before the start of the secular birth decline, perhaps with the exception of the towns around Frankfurt and of some communities in the central parts of Prussia. The pattern of “illegitimate fertility” (fig. 4) almost presents itself as the opposite of the level of marital fertility. Comparatively high values can be found in the central and eastern provinces whereas the Rhineland, Westphalia, and Hesse-Nassau are marked by extremely low figures. The only exception, namely the high level of Bonn, is to be attributed to a large home for unmarried mothers. In contrast to both dimensions of fertility the “proportion married” (fig. 5) shows a pattern which is much more differentiated. A homogeneous regional level can be noticed only in the most eastern provinces. Moreover, the close proximity of cities with very different figures seems to be a characteristic feature of the pattern. This holds true for the

area of Berlin and the Rhineland, the latter showing a distinct contrast between the cities in the Ruhr-area and the communities on the left bank of the river Rhine. Finally, the index of “overall fertility” (fig. 6) can be interpreted as the resultant of the different fertility dimensions, shown on the preceding maps. Obviously the pattern seems to be more affected by the differences in the proportion married than by the levels of marital fertility.

Determinants of reproductive behaviour

Proceeding from these observations the basic hypothesis of the investigation can be formulated more precisely: It can be supposed that the fertility behaviour of the populations in the Prussian cities is mainly determined by two more or less independent groups of factors. These are determinants which are primarily associated with regional cultural patterns on the one hand, and factors which seem to be closely connected with the prevailing social structures and economic functions of the cities on the other hand. Obviously the dimensions “marital fertility” and “illegitimate fertility” are primarily determined by the effects of regional location,

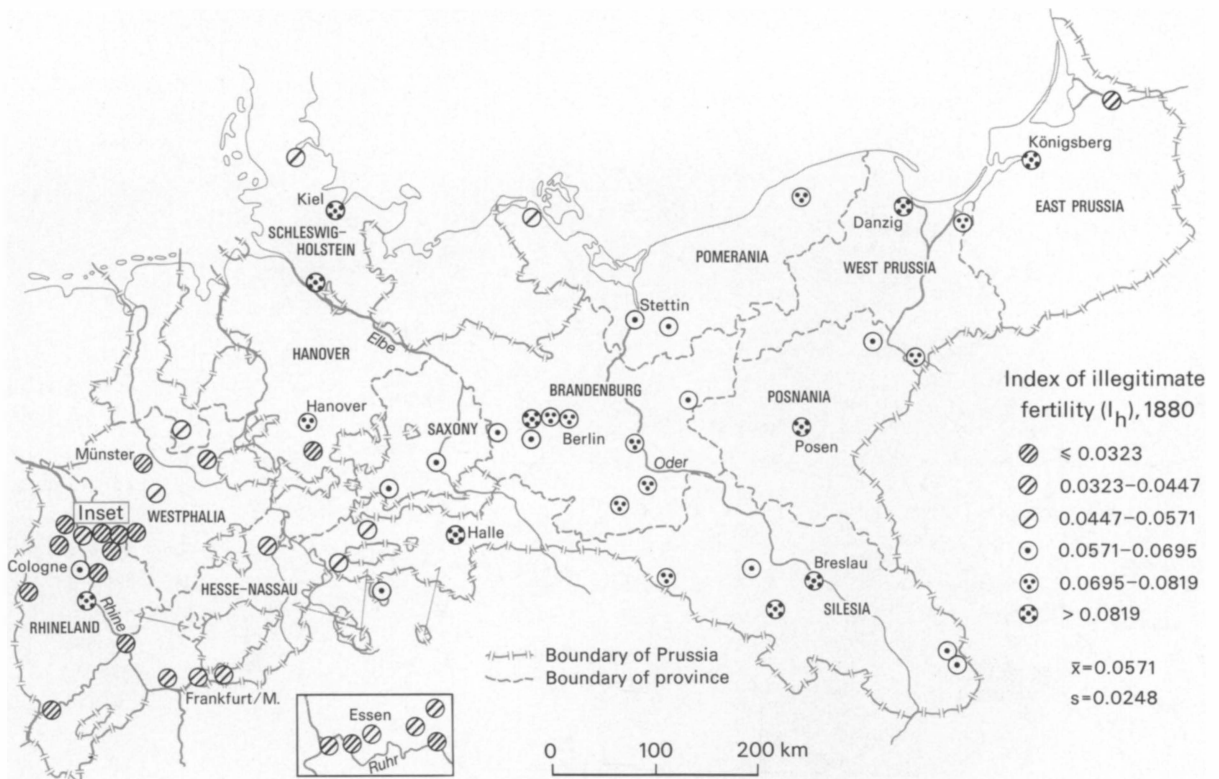

Fig. 4: Index of illegitimate fertility (I_h), 1880

whereas the “proportion married” and the “overall fertility” mainly reflect the structural characteristics of the different cities.

Before discussing and testing these assumptions in detail, the cities had to be classified according to the different categories of factors just mentioned. At first the territory of Prussia was divided into four coherent regions. An attempt was made to delineate areal units as homogeneous as possible as far as the cultural and historical traditions and the denominational structure are concerned. Thus the following subdivision was chosen: The first region includes the most eastern parts of Prussia, i. e. the provinces located east of the river Oder. The second area embraces the central provinces of Saxony and Brandenburg, including Berlin as the capital of the German Empire. The third regional unit consists of the provinces of Schleswig-Holstein, Hanover, and Hesse-Nassau whereas the fourth region is represented by the most western parts, i. e. the provinces of Rhineland and Westphalia.

In a second step a functional classification of the cities into seven different types was carried out, based on the employment data reported by the occupation and industrial censuses of 1882 and 1907. The different types were defined according to the most important economic activity in each city and with reference to the relatively simple method

worked out by H. J. NELSON (1955)⁴⁾. The location of the different types for 1880 is given on the map in fig. 7⁵⁾. It is remarkable that the cities dominated by the secondary sector of the economy are concentrated in the western parts of Prussia. In contrast to this, the eastern parts of the country are characterized by a preponderance of commercial and service centres of different size as well as by administrative and garrison towns. This strong contrast between East and West can be considered as the result of distinct levels of economic development in the different parts of Prussia. Moreover, the regional distribution of the diverse types of cities reveals that economic orientation and regional location cannot be regarded as completely independent categories.

It seems to be appropriate now to discuss the theoretical implications of both the functional types of cities and the regional subdivisions for the explanation of the generative behaviour. One of the most significant findings of KNODEL’s

⁴⁾ For the detailed criteria of classification, see LAUX (1982).

⁵⁾ The classification was carried out separately for 1880 and 1905. Between these dates only 17 cities (26.6%) moved from one type to another. Most of the changes occurred between similar categories. Only one city altered its basic characteristics moving from type 6 to type 1.

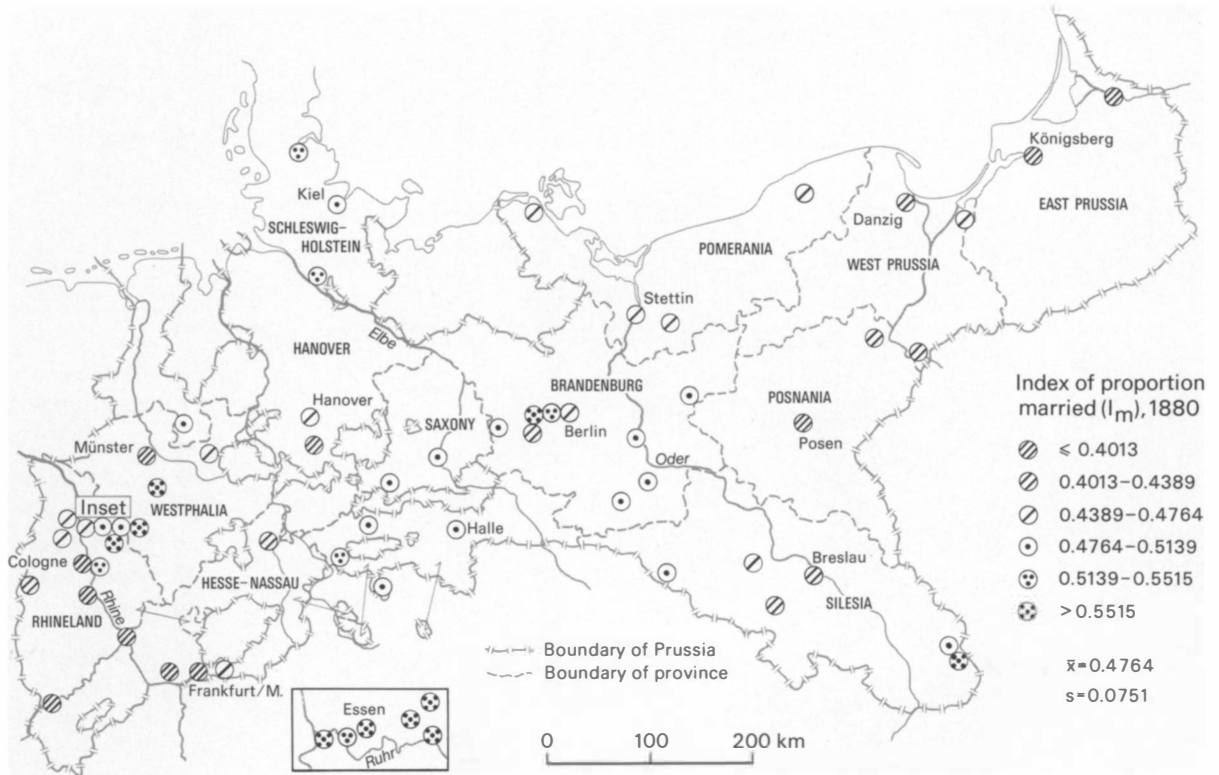

Fig. 5: Index of proportion married (I_m), 1880

study mentioned before is that within Germany substantial areal differences existed with respect to the pre-decline levels of fertility and the dates and rates of the birth decline itself. These territorial variations are attributed to the “effects of regional cultural patterns that may be difficult or impossible to measure directly”, as KNODEL says (1974, 250). Nevertheless, the denominational affiliation can be considered as one of the most important indicators for the existence and the effects of such cultural patterns. The contrast between predominantly catholic and protestant areas undoubtedly reflects the existence of different attitudes and norms towards birth control and sexual behaviour. Moreover, the denominational variations are obviously correlated with different degrees of the secularization and modernization of the German society at the turn of the century. Thus it seems to be characteristic that the percentage of votes for the socialist party in 1907 is influenced more by the percentage of protestants ($r = 0.662$) than by the proportion of persons employed in manufacturing ($r = 0.297$). If my hypothesis is correct a rising percentage of Roman catholics should lead to

an increasing level of marital fertility and to decreasing values of the proportion married⁶⁾.

It is assumed by the different theories of fertility developed on a microanalytical level that the reproductive behaviour of populations is influenced by a variety of social and economic variables, such as social status, occupational position, wealth and income level, female job participation and so on. Undoubtedly, in the period under discussion an urban population which is characterized by a strongly differentiated social stratification, including a comparatively high proportion of upper and middle class families, will show a lower aggregate level of marital fertility than a local population which is dominated by members of the working class only. Thus in manufacturing towns a higher level of marital fertility can be expected compared with those cities which are dominated by tertiary activities and where a higher proportion of more qualified jobs is to be found, such as civil servants, independent professionals, and persons engaged in trade and transport. It is not only the different level of income that divides these traditional urban groups from the industrial workers. Moreover, the different lifestyles and value systems can be considered as highly relevant to the fertility behaviour.

In contrast to the facts just discussed, it is a question not yet solved, to what extent the level of marital fertility is

⁶⁾ For a detailed discussion of the interrelations between religious affiliation, secularisation, and fertility behaviour, see LESTAEHGE a. WILSON (1982).

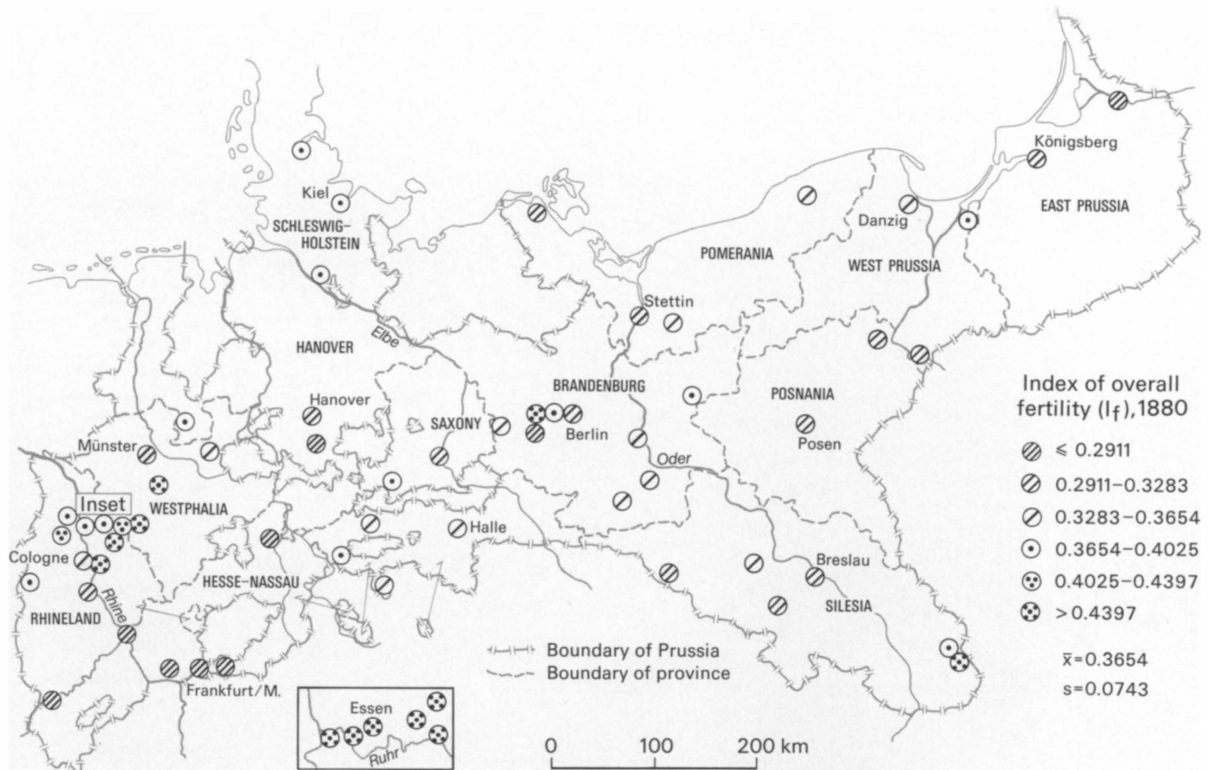

Fig. 6: Index of overall fertility (I_f), 1880

affected by different kinds and degrees of female job participation. It can be generally accepted that in the period under discussion female employment was mainly restricted to unmarried women (TILLY, SCOTT, COHEN 1976, 463). Thus the negative correlation between the degree of female job participation and the level of marital fertility in the Prussian cities around 1905 ($r = -0.496$) must be interpreted primarily as the result of an indirect effect. This means that a high proportion of employed women leads to a higher mean age at first marriage thus reducing the average number of children born to a married woman.

This argumentation leads to the question for the causes of the striking inter-city variations of the "proportion married". Two demographic dimensions can be considered as the most important determinants of the proportion married of female population. These are the sex ratio of the unmarried adult population on the one hand, and the mean age at first marriage for men on the other (KNODEL, MAYNES 1976). The latter variable has a decisive influence in a population whose growth is mainly due to the immigration of young adults of both sexes; in such a population a late age at marriage for men generally leads to a high percentage of unmarried young women. Nevertheless, the two demographic determinants must be interpreted as intervening variables, which are primarily determined by the structures

and conditions of the local labour market. But this labour market itself can be considered as the direct result of the economic function of the specific city.

One of the most remarkable characteristics of the biography and the socio-economic conditions of industrial workers in the period under discussion is the significantly changing level of wage earnings according to the age of the employed person. Generally, both the unskilled and the skilled workers reached their maximum earning power at the age of about 25 years. After a phase of 15–20 years, which was characterized by a stagnation of income, the wages began to decline very often from the age of about 40 years. This was particularly the case for those unskilled wage-earners whose only qualification consisted of their physical ability to work hard (SCHÄFER 1981, WEBER 1912).

It is obvious that these different stages of income were of great importance for the family life cycle of the working class (L. TILLY 1979). As far as marriage behaviour is concerned, it can be argued that the comparatively high wage-earnings at the beginning of the industrial workers' professional career are responsible for the early and almost universal marriage in the cities dominated by secondary activities. Moreover, it must be noticed that – due to the unbalanced sex ratio in most of the manufacturing cities – the prospects of getting married were extraordinarily high



Fig. 7: Functional classification of cities, 1880/82

for young women. This does not apply to textile towns though, which traditionally showed a high percentage of female job participation. In these towns the predominance of adult women lead to a high mean age at first marriage as well as to a comparatively low level of the proportion married of female population (WRIGLEY 1961, 145).

As already mentioned the occupational structure, together with the social stratification and the income structure, seems to be much more differentiated in those towns which were dominated by the tertiary sector of economy. This means that, apart from highly qualified occupations characterized by a long period of training, there also existed a variety of unskilled employees in the different branches of the service sector. As these occupations, such as domestic servants or clerks, generally did not pay well, it was impossible to found a family before the end of the twenties, if at all. Thus it can be expected that the distinct social stratification of the service towns and their preponderance of young adult women – the garrison towns must be excluded here – lead to a lower marriage frequency and to a late mean age at first marriage.

To sum up the results of the discussion, it can be assumed that there is a distinct differentiation of “marital fertility” and “proportion married” according to the socio-economic

structures and the prevailing functions of the cities. As was argued, the municipalities predominantly characterized by the different manufacturing activities will show the highest levels of “marital fertility” and also – with the exception of the textile towns – of the “proportion married”. This is in strong contrast to those cities, which are dominated by tertiary activities: They will be marked by low levels of the demographic dimensions, particularly of the “proportion married”. The communities classified as “diversified cities” are assumed to hold an intermediate position.

Concerning the interdependence of the two basic components of reproductive behaviour, it can be assumed that on the aggregate level of cities marital fertility as well as marriage frequency tend to the same direction under the influence of the different socio-economic conditions discussed above. Thus according to the scheme developed by J. MATRAS (1965), the “strategy of family formation” characterized by early and general marriage and by a more or less uncontrolled fertility must be considered as one possible path from pre-industrial to modern reproductive behaviour. Obviously this path is primarily realized by the populations of industrial cities. It can therefore be interpreted as a distinct proletarian pattern of reproductive behaviour. This view is in agreement with the suggestion of CH. TILLY (1978,

49) and his emphasis on proletarianization as a decisive stage of social and demographic history.

Results

At this point it seems to be appropriate to test the discussed hypotheses empirically. At first this is done by means of two diagrams, which show the relation between the different indices of fertility in 1880 and 1905, plotted in the well known manner developed by A. COALE and his colleagues (supplement I). The different types of cities are marked by colours whereas the regional location is indicated by geometrical symbols. The diagram for the year 1880 reveals clear and distinct patterns. Thus the different service towns can be found mainly in the lower and left field of the point cluster, in contrast to the manufacturing towns concentrating in the upper right corner of the diagram. Moreover, it can be seen that the cities located in the most western provinces, i. e. Rhineland and Westphalia, largely concentrate in the upper area of the plot, whereas those in the central provinces of Prussia can be found mainly in the lower parts of the point cluster, thus indicating the lowest levels of marital fertility. This impressive contrast reflects the difference between the predominantly catholic areas in the western parts of the country, and exclusively protestant areas in the central parts of Prussia.

The diagram for the year 1905 is characterized by a significantly larger range of the index of "marital fertility". This increased variation of fertility is the result of a regionally differentiated birth decline between 1880 and 1905. As can be seen, this decline was most intensive in the cities of the predominantly protestant provinces, such as Brandenburg, Saxony, Hanover or Hesse-Nassau. In contrast to this, the provinces of Rhineland and Westphalia and also the most eastern parts of Prussia were still less affected by the secular fertility decline. Apart from this, the diagram obviously shows a very similar structure compared with 1880, if we consider the relative position of the different types of cities.

Finally, a statistical test, which is much more reliable than a pure description of the diagrams, was carried out by means of an analysis of variance or by multiple classification analysis. The most important results of this analysis can be found in table 3. In the first columns the arithmetic means of the demographic indices are reported both for the different types of cities and for the different regions. As these two explanatory categories are not totally independent, the means mutually adjusted for the effects of the other dimension are given in the second columns. The eta-coefficients also reported in the table can be interpreted as simple correlation coefficients between each of the two explanatory factors and the different demographic dimensions, whereas the beta-values correspond to the partial regression coefficients. The square value of the multiple correlation coefficient indicates the proportion of variance explained by the two independent categories.

It is not necessary to discuss the results of the multiple classification analysis in all respects. Instead the most important findings should be cited:

As can be seen from the square of the multiple correlation coefficients generally more than two thirds of the variance of the different demographic dimensions can be explained by the overall effect of the two independent categories. But the beta-values indicate that the contribution of these two factors differ significantly from one dimension to the other. Thus the level of "marital fertility" is primarily determined by the regional subdivision, i. e. the effects of the regional cultural patterns mentioned before. In contrast to this, the "proportion married" as well as the "overall fertility" are mainly influenced by the functional classification of the cities, i.e. the complex of socio-economic determinants. It is remarkable that there is a striking similarity between the coefficients for 1880 and 1905. This can be interpreted as an expression of a strong persistence of demographic patterns and processes.

If one looks at the means of the demographic indices for the different types of cities, an almost perfect correspondence can be found between the two dates as far as the gradation of the values of the "proportion married" is concerned. The lowest levels are associated with those cities which are dominated by tertiary economic activities, whereas the "mining cities" and the "other manufacturing cities" are characterized by values significantly above average. This result largely verifies the assumptions concerning the variation of marriage behaviour.

With respect to "marital fertility", a clear gradation of values can be found according to the functional types of cities in 1880. Here the three groups of manufacturing cities are marked by levels of marital fertility which are significantly higher than those of the remaining categories, thus giving support to the hypothesis of a distinct proletarian type of reproductive behaviour. It is remarkable that this gradation has disappeared by 1905. Apart from the striking exception of the mining towns, whose extraordinary level of fertility can be considered as an international phenomenon (FRIEDLANDER 1973, HAINES 1977), the seven types of cities do not show any significant difference in marital fertility as far as the adjusted values are concerned. In contrast to this the inter-regional variation of the fertility levels has increased. This can be seen by comparing the provinces of Rhineland and Westphalia with the central parts of Prussia, particularly with the provinces around the capital Berlin. That means that the different levels of marital fertility, as well as the different rates of birth decline, are widely associated with the prevailing denominational structure of the urban populations in the way suggested above.

Considering the index of "overall fertility", i. e. the composite effect of "marital fertility" and "proportion married", a differentiation of the values according to the functional classification of the cities can be found again for both dates. But, apart from the mining cities, an obvious reduction of the variations between the different types occurred from 1880 to 1905 combined with a slight increase

Table 3: Multiple classification analysis: Fertility indices, 1880 and 1905

1880	N	Marital fertility				Proportion married				Overall fertility			
		Unad-justed mean	eta-value	Ad-justed mean	beta-value	Unad-justed mean	eta-value	Ad-justed mean	beta-value	Unad-justed mean	eta-value	Ad-justed mean	beta-value
Types of cities													
Commercial a. service centres	13	0.6525		0.6833		0.4292		0.4319		0.3169		0.3290	
Administrative a. garrison towns	7	0.6588		0.6648		0.4248		0.4229		0.3130		0.3136	
University a. retirement towns	7	0.6611		0.6715		0.3996		0.4016		0.2970		0.3026	
Mining towns	6	0.8030		0.7567		0.5826		0.5975		0.4869		0.4787	
Textile towns	5	0.7748		0.7229		0.4856		0.4878		0.3938		0.3778	
Other manufacturing towns	8	0.7714		0.7294		0.5523		0.5556		0.4482		0.4373	
Diversified cities	18	0.6751	0.64	0.6949	0.32	0.4886	0.76	0.4796	0.79	0.3623	0.81	0.3631	0.72
Regional subdivision													
Eastern provinces	17	0.6781		0.6853		0.4395		0.4551		0.3396		0.3532	
Berlin-Brandenburg-Saxony	15	0.6463		0.6534		0.5019		0.5122		0.3602		0.3717	
Schleswig-Holstein – Han- over – Hesse-Nassau	10	0.6100		0.6230		0.4550		0.4845		0.3108		0.3363	
Rhineland – Westphalia	22	0.7915	0.82	0.7752	0.68	0.4971	0.36	0.4647	0.29	0.4138	0.52	0.3837	0.23
Grand mean	64	0.6990				0.4764				0.3654			
Multiple R ²		0.751				0.656				0.702			

1905	N	Marital fertility				Proportion married				Overall fertility			
		Unad-justed mean	eta-value	Ad-justed mean	beta-value	Unad-justed mean	eta-value	Ad-justed mean	beta-value	Unad-justed mean	eta-value	Ad-justed mean	beta-value
Types of cities													
Commercial a. service centres	12	0.4845		0.5237		0.4776		0.4667		0.2631		0.2745	
Administrative a. garrison towns	8	0.5372		0.5223		0.4473		0.4516		0.2664		0.2599	
University a. retirement towns	6	0.5392		0.5254		0.4200		0.4204		0.2518		0.2449	
Mining towns	5	0.7402		0.6846		0.5840		0.5975		0.4505		0.4311	
Textile towns	6	0.5354		0.5229		0.4844		0.4878		0.2749		0.2735	
Other manufacturing towns	9	0.5795		0.5333		0.5727		0.5830		0.3482		0.3340	
Diversified cities	18	0.4932	0.60	0.5211	0.39	0.4999	0.73	0.4951	0.80	0.2734	0.75	0.2841	0.66
Regional subdivision													
Eastern provinces	17	0.5785		0.5729		0.4740		0.4844		0.3080		0.3093	
Berlin-Brandenburg-Saxony	15	0.4234		0.4375		0.5092		0.5148		0.2439		0.2545	
Schleswig-Holstein – Han- over – Hesse-Nassau	10	0.4602		0.4737		0.4872		0.5226		0.2520		0.2761	
Rhineland – Westphalia	22	0.6166	0.73	0.6053	0.63	0.5109	0.24	0.4829	0.25	0.3338	0.53	0.3146	0.35
Grand mean	64	0.5368				0.4970				0.2931			
Multiple R ²		0.669				0.582				0.667			

of the inter-regional differences. Nevertheless, the gradation of the overall fertility still remains distinct enough to confirm the basic hypothesis of this paper.

References

- COALE, A. J.: The Decline of Fertility in Europe from the French Revolution to World War II. In: BEHRMANN, S. J., CORSA, L., FREEDMAN, R. (Eds): *Fertility and Family Planning*. Ann Arbor 1969, 3–24.
- EVERSLEY, D.E.C.: Population, Economy and Society. In: GLASS, D., EVERSLEY, D. E. C. (Eds): *Population in History. Essays in Historical Demography*. London 1965, 23–69.
- FRIEDLANDER, D.: Demographic Patterns and Socioeconomic Characteristics of the Coal-Mining Population in England and Wales in the Nineteenth Century. In: *Economic Development and Cultural Change* 22, 1973, 39–51.
- HAINES, M. R.: Fertility, Nuptiality, and Occupation: A Study of Coal Mining Populations and Regions in England and Wales in the Mid-Nineteenth Century. In: *Journal of Interdisciplinary History* 8, 1977, 245–280.
- KNODEL, J. E.: *The Decline of Fertility in Germany, 1871–1939*. Princeton, N. J. 1974.
- KNODEL, J., MAYNES, M. J.: Urban and Rural Marriage Patterns in Imperial Germany. In: *Journal of Family History* 1, 1976, 129–168.
- KÖLLMANN, W.: *Bevölkerung in der industriellen Revolution*. Göttingen 1974.
- KULS, W.: Regionale Unterschiede im generativen Verhalten. In: *Innsbrucker Geographische Studien* 5, 1979, 215–228.
- LAUX, H.-D.: Demographische Folgen des Verstädterungsprozesses: Zur Bevölkerungsstruktur und natürlichen Bevölkerungsentwicklung deutscher Städtetypen 1871–1914. In: TEUTEBERG, H. J. (Ed): *Urbanisierung im 19. und 20. Jahrhundert*. Köln-Wien 1982, 65–95.
- LESTAEGHE, R., WILSON, CH.: Les modes de production, le laïcisation et le rythme de baisse de la fécondité en Europe de l'Ouest de 1970 à 1930. In: *Population* 37, 1982, 623–646.
- MATRAS, J.: The Social Strategy of Family Formation: Some Variations in Time and Space. In: *Demography* 2, 1965, 349–362.
- NELSON, H. J.: A Service Classification of American Cities. In: *Economic Geography* 31, 1955, 189–210.
- SCHÄFER, H.: Arbeitsverdienst im Lebenszyklus. Zur Einkommensmobilität von Arbeitern. In: *Archiv für Sozialgeschichte* 21, 1981, 237–267.
- TILLY, CH. (Ed): *Historical Studies of Changing Fertility*. Princeton, N. J. 1978.
- TILLY, L.: The Family Wage Economy of a French Textile City: Roubaix, 1872–1906. In: *Journal of Family History* 4, 1979, 381–394.
- TILLY, L., SCOTT, J., COHEN, M.: Women's Work and European Fertility Patterns. In: *Journal of Interdisciplinary History* 6, 1976, 447–476.
- VAN DE WALLE, E.: Marriage and Marital Fertility. In: *Daedalus* 97, 1968, 486–501.
- WEBER, A.: Das Berufsschicksal der Industriearbeiter. Ein Vortrag. In: *Archiv für Sozialwissenschaft und Sozialpolitik* 34, 1912, 377–405.
- WRIGLEY, E. A.: *Industrial Growth and Population Change. A Regional Study of the Coalfield Areas of North-West Europe in the Later Nineteenth Century*. Cambridge 1961.

Statistical Sources

- Preußische Statistik, Volumes 51 (1880), 56 (1881), 61 (1882), 66 (1883), 68 (1883), 74 (1884), 76,1 (1884), 196 (1905), 200 (1906), 206 (1908), 207 (1907)
- Statistik des Deutschen Reiches, Volume 209 (1910)

Generative structure

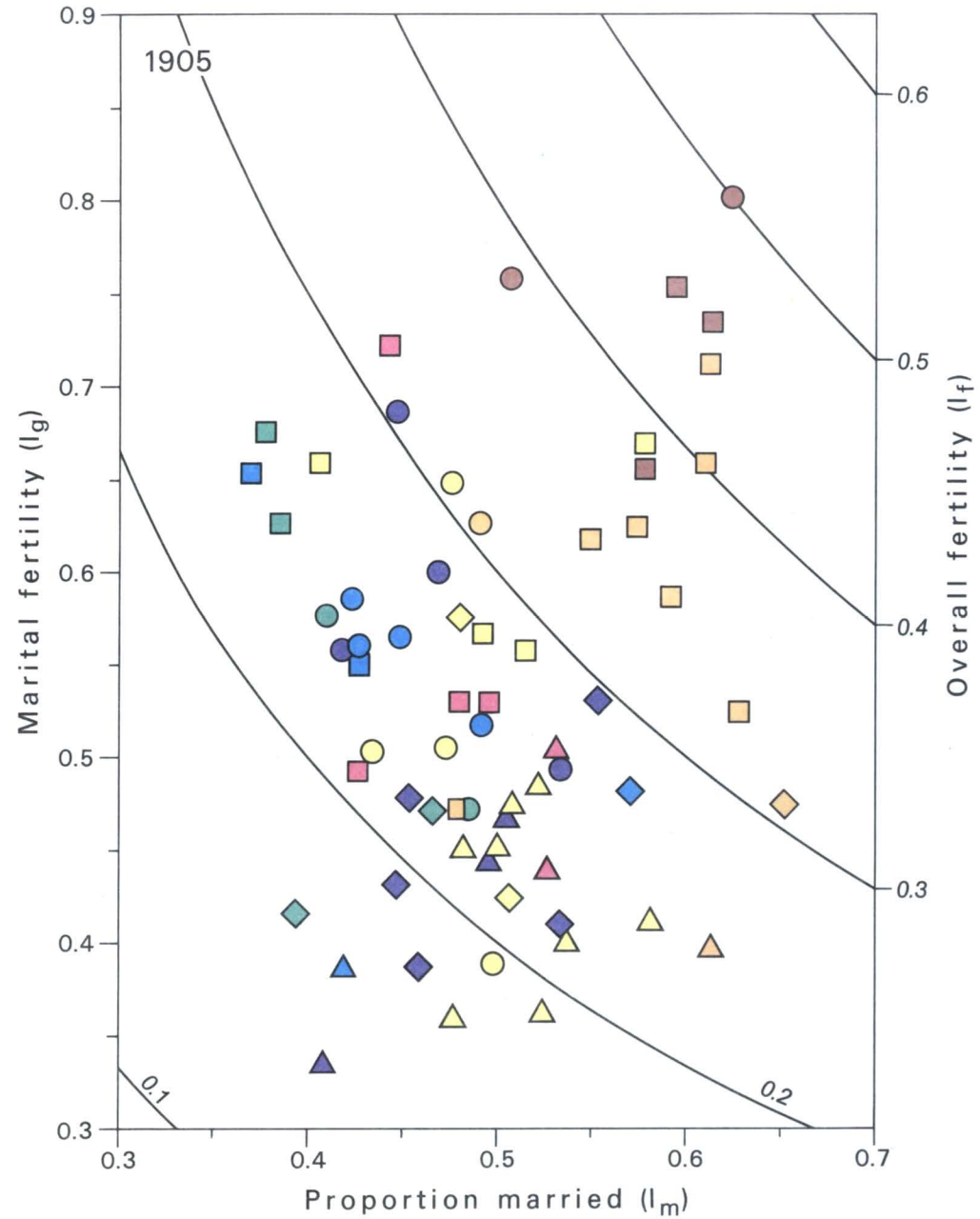
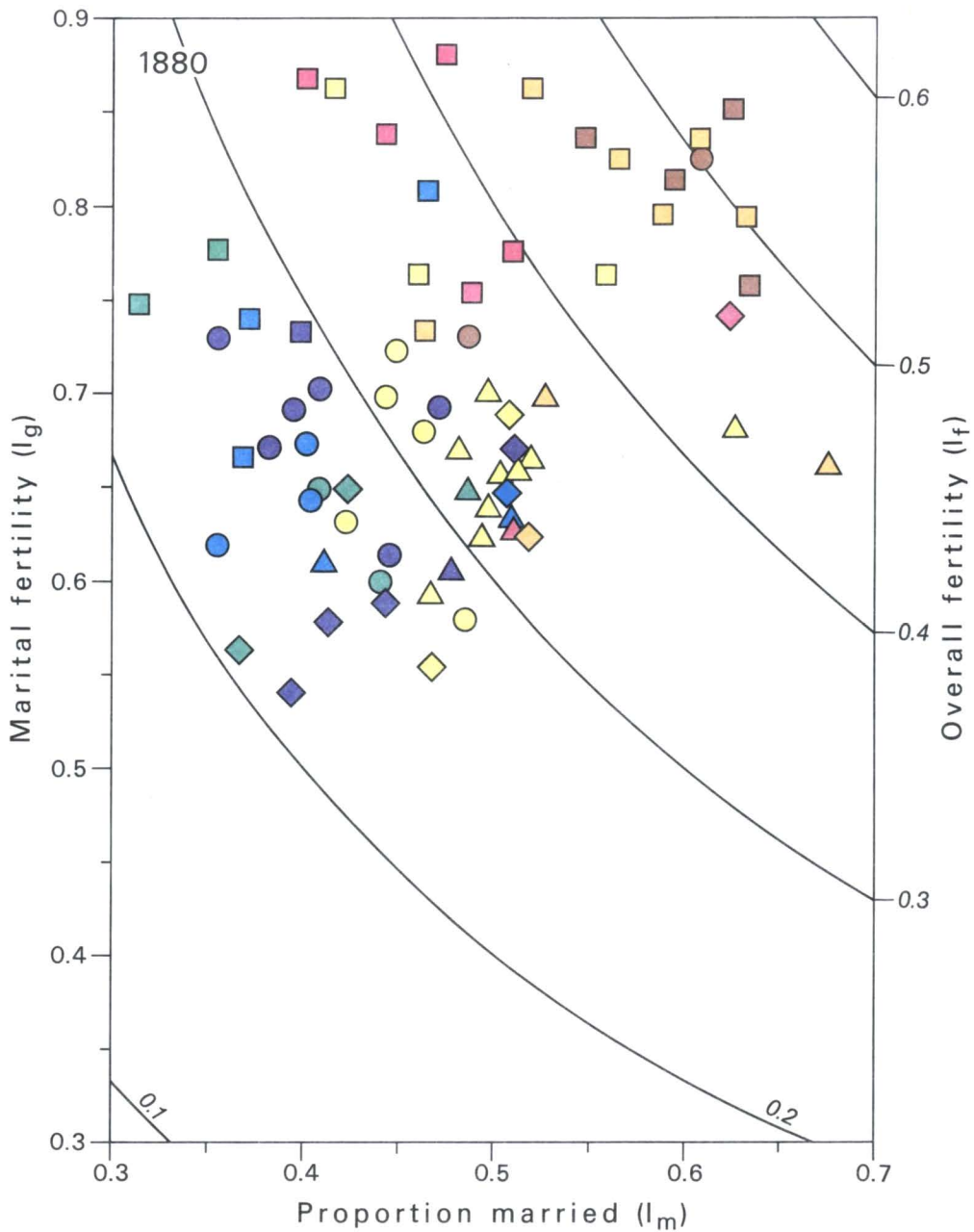

Functional classification

- Commercial and service centres
- Administrative and garrison cities
- University and retirement cities
- Diversified cities
- Mining cities
- Textile cities
- Other manufacturing cities

Regional subdivision

- Eastern provinces
- △ Berlin – Brandenburg – Saxony
- Schleswig–Holstein – Hanover – Hesse–Nassau
- ◇ Rhineland – Westphalia